

Evaluation Hardware/Software Manual for ALS and Proximity Sensor

<http://www.intersil.com/lightsensor/>

Ambient Light Sensor Products

ISL29011 FAMILY			
	ALS	IR	PROXIMITY
ISL29011	X	X	X
ISL29018	X	X	X
ISL29021		X	X
ISL29023	X	X	
ISL29033	X	X	
ISL29028 FAMILY			
ISL29027			X
ISL29028/ISL29028A	X	X	X
ISL29030/ISL29030A	X	X	X
ISL29040/ISL29042	X	X	X
STAND ALONE			
ISL29020	X	X	

Evaluation Boards

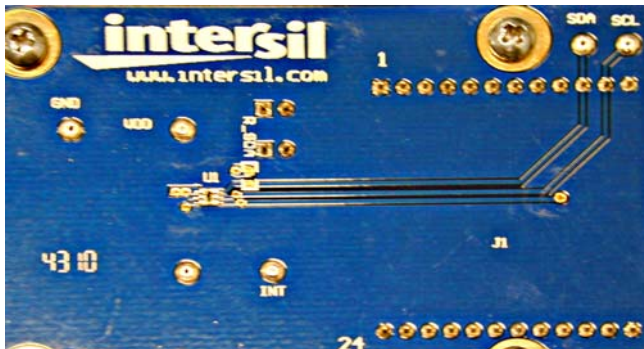

FIGURE 1. ISL29023 EVALUATION BOARD

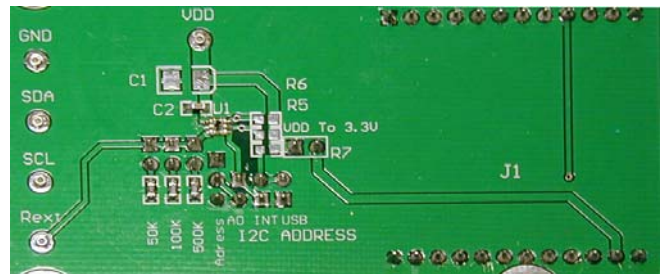

FIGURE 2. ISL29020 EVALUATION BOARD

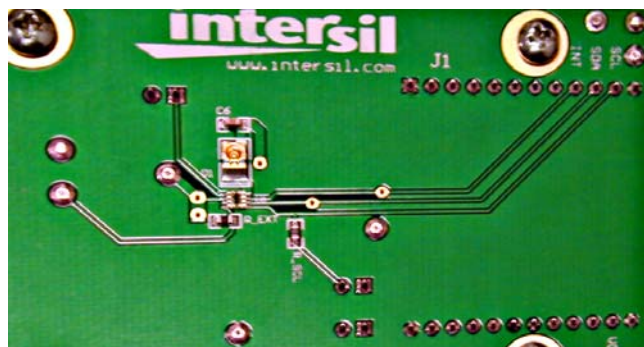

FIGURE 3. ISL29028 EVALUATION BOARD

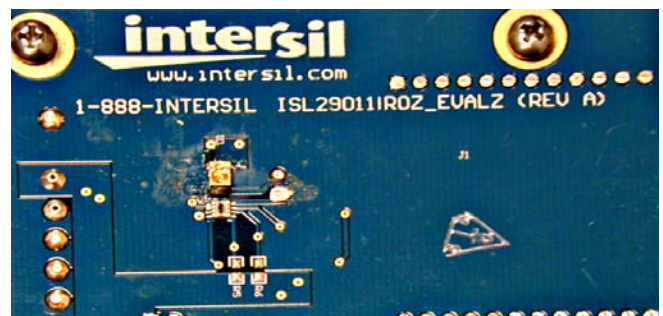

FIGURE 4. ISL29011 EVALUATION BOARD FAMILY

Table of Contents

Ambient Light Sensor Products	1
Evaluation Boards	1
Table of Contents	2
Evaluation Package	3
System Requirements	3
Software Installation	3
Firmware Reference	3
Evaluation Kit Contents	3
Hardware Setup for ISL29011 Family	3
Running Program for ISL29011 Family	3
Hardware Setup ISL29028 Family	8
Troubleshooting	11
Evaluation Boards Schematics	12

Evaluation Package

- Demo Board
- Evaluation Software (online)
- USB 2.0 Cable

System Requirements

- Windows 98/NT/2000/XP/VISTA/WIN7
- Available USB Port

Software Installation

- Intersil_ISL29XXX_HID(V107).exe
or:
- intersil_ISL29011,ISL29018,ISL29021,ISL29023 Installer V107.exe

Firmware Reference

- [Intersil_ISL29xxx_HID\(V107\).exe](#), which has Human Interface Device firmware in the Micro-controller board ([ISLUSBCEVAL1Z-HID_REV1](#)). It can therefore communicate with Intersil Ambient Light Sensor products using a PC operating on Windows 98/NT/2000/XP/VISTA/WIN7.
- [ISL29011,ISL29018,ISL29021,ISL29023 Installer V107.exe](#), which has Jungles firmware in the Micro-controller board ([ISLUSBCEVALS1Z-REVA](#)). It can therefore communicate with Windows 98/NT/2000/XP but not VISTA and WIN7.

Note: If you have trouble with Firmware, please see "Troubleshooting" on page 10.

Evaluation Kit Contents

The evaluation kit consists of the hardware, software, and documentation listed in the following.

1. Evaluation PCB
2. PDF of board schematic (online)
3. PDF of board layout (online)
4. Evaluation Software Installer (online)
5. Evaluation Board manual (online)
6. IC Data sheets (online)

The software and documentation can be found in the following links:

- <http://www.intersil.com/products/deviceinfo.asp?pn=ISL29028>
- <http://www.intersil.com/products/deviceinfo.asp?pn=ISL29011>
- <http://www.intersil.com/products/deviceinfo.asp?pn=ISL29018>
- <http://www.intersil.com/products/deviceinfo.asp?pn=ISL29021>
- <http://www.intersil.com/products/deviceinfo.asp?pn=ISL29023>
- <http://www.intersil.com/products/deviceinfo.asp?pn=ISL29020>
- <http://www.intersil.com/products/deviceinfo.asp?pn=ISL29027>

Installing the Software

From the link supplied in the previous section, download and run *Intersil_ISL29XXX_HID_Installer_V107.exe*. The user will be greeted by the screen shown in Figure 5. Continue through the installer and read the instructions. The PC and PCB should *not* be

connected via the USB until after the installation has satisfactorily completed.

- Double-click *Intersil_ISL290XXX_HIDV1.07.Installer.exe*

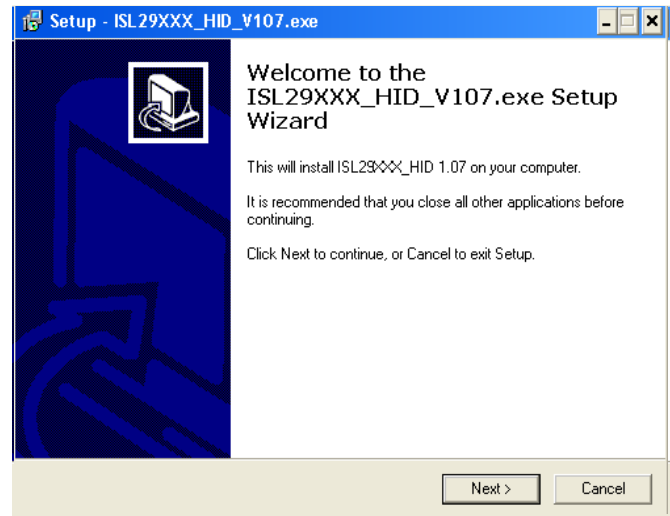

FIGURE 5.

Hardware Setup for ISL29011 Family

- Connect the USB 2.0 Cable to the PC first, and then to the Evaluation Board
- The computer may ask about installing software for new found hardware; select "Yes, this time only"
- On the following screen, it will ask about how to install hardware. Select the recommended option (Installing from CD) and follow the directions
- The USB is the only connector needed

Running Program for ISL29011 Family

- To open the program, go to the "Start" menu, as shown in Figure 6 (Start → Intersil → Intersil_29XXX_HID → Intersil_29XXX_HID)



FIGURE 6.

- Once you have double clicked the program, the window displayed in Figure 7 should open.

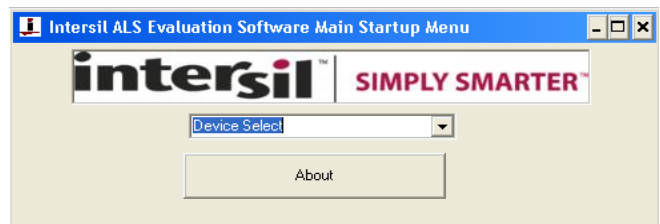

FIGURE 7.

Application Note 1591

- Go to “Device Select” tab and select whichever Device you have connected to your computer; for this example we will use “ISL29011”, as shown in Figure 8.

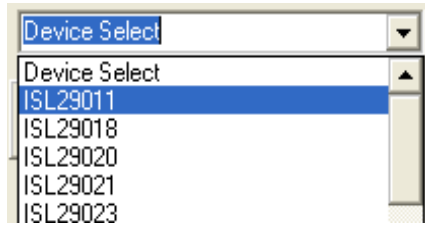

FIGURE 8.

- The “ISL29011 Multi-Function Sensor Evaluation Software” window should open
- This is the main window in which all demonstrations will be done
- **USB Communication**- Check to make sure the light shown in Figure 9 is green. If it is not green, check your connection.



FIGURE 9.

- **Test Communication** with the IC by clicking the button shown in Figure 10; if it shows “good”, then the Hardware and Software are properly set up; if it says “fail”, then check your connections. If the problem still persists, then you may want to restart the software.

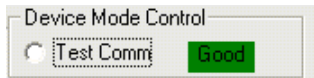

FIGURE 10.

Note: This is common for all devices

- From the menu on the left, choose the specific “**Operation**” in which you would like to operate the IC, as shown in Figure 11. A detailed explanation is described in the data sheet (FN6691). Table 1 summarizes the different modes.

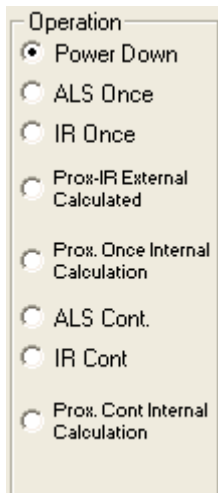

FIGURE 11.

TABLE 1.

MODE	EXPLANATION
Power-down	Turn off and keep data in registers.
ALS Once	Ambient Light Sense for one conversion then Power-down.
IR Once	Infrared Sense for one conversion then Power-down.
Prox. Once Internal Calc.	Proximity Infrared Sense for one conversion then Power-down; Flagging is triggered by Interrupt.
ALS Cont.	Ambient Light Sense continuously and continue to refresh registers.
IR Cont	Infrared Sense continuously and continue to refresh registers.
Prox. Cont Internal	Proximity Infrared Sense continuously and continue to refresh registers; Flagging is triggered by Interrupt (Scheme1).
Prox. Cont External	Proximity Infrared Sense continuously and continue to refresh registers; Flagging is triggered by Interrupt (Scheme0).

- **Integration Time** in Figure 12, corresponds to the resolution of the internal ADC and the number of bits allocated to representing Count. Higher resolution (more bits) requires a large number of counts and will need longer acquisition (integration) time.

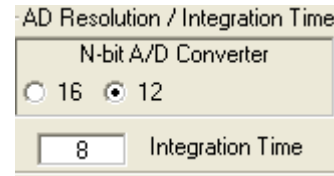

FIGURE 12.

- **Sensitivity-Range Select** (Figure 13) allows us to choose the sensitivity of the sensor based on external conditions/object detection. For example, a really bright object would require a higher range (i.e. 64000), versus a dark object, which would require a low range (i.e. 1000). Higher range reduces photo detector sensitivity.

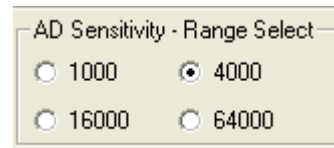

FIGURE 13.

The section shown in Figure 14 allows the user to choose either external prox or internal prox calculation.

Scheme0(external prox): Not recommended because subtraction is done by the software.

Scheme1(internal prox): Recommended because subtraction performed by system on chip

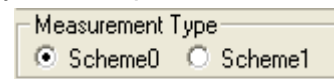

FIGURE 14.

Application Note 1591

The section shown in Figure 15 is for proximity mode:

Source Current allows you to adjust the IR LED driving current. A greater current allows for the detection of objects at farther distances.

IR Modulation Frequency allows you to modulate the IR LED driving current. Increasing the frequency parameter allows for better noise immunity.

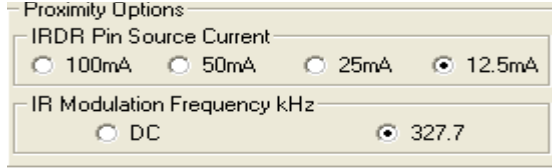

FIGURE 15.

This section shown in Figure 16 displays data of Device Registers:

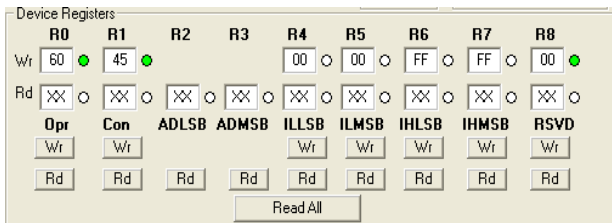

FIGURE 16.

REGISTER 0X00 – CONFIGURE MODEL

IC register 0x01 controls the modes such as ALS/IR/Prox and Interrupt flag and Interrupt persistence of the part, which are explained in detail in the data sheet.

REGISTER 0X01 – CONFIGURE MODES II

IC register 0x02 controls the ranges and resolutions of the part and also Scheme for Proximity.

REGISTER 0X02 AND 0X03

Data will be stored to these registers.

REGISTERS 0X03 TO 0X07 – INTERRUPT THRESHOLDS

The PROX interrupt and ALS thresholds are stored in registers 0x03 to 0x07. They can be edited by writing values to the “Interrupt Limits” box and clicking “write”. See the IC data sheet for more information on interrupt limits.

The section shown in Figure 17 allows the user to set the interrupt trip-point, which acts as an alarm/monitoring function to determine whether the ADC count exceeds the upper/lower limit.

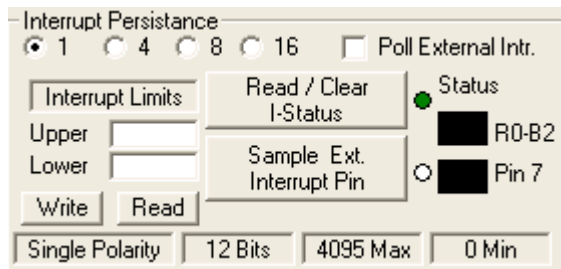

FIGURE 17.

Interrupt Persistence	Sets the number of times the upper limit needs to be exceeded or lower limit needs to be subceeded. Once the allotted number of times is achieved, an alarm/interrupt will flag
Interrupt Limits	Type the upper threshold for the interrupt in the top box (Max = 65535 for Int. Time = 16; Max = 4095 for Int. Time = 12) Type the lower threshold for the interrupt in the bottom box (Min = 0, for either Int. Time)
Write	Stores value to memory in Registers 4-7
Read	Read limit values stored in Registers 4-7
Read/Clear I-Status	Checks the 2 nd bit of Register 0 to determine Interrupt status, whether interrupt thresholds have been triggered or not. It then displays the results in the “Status” section. The R0-B2 box displays the status of the interrupt. To clear the interrupt status, click 2 times on “Read/Clear” button. - Green light means the button is on and value from bit 2 from R0 has been read - Square light displays status; if black then interrupt is off/not triggered yet; if red then interrupt has been triggered
Sample Ext. Interrupt Pin	Samples the external Pin 7 on package of the IC - Green light means, button is on and is displaying output of Interrupt pin (7 th pin) - Square light displays the status; black means trigger hasn’t been triggered yet - Red means interrupt has just been triggered
Poll External Intr.	Allows for checking of External Interrupt Status while sampling data.

To use:

1. Choose Interrupt Persistence value (we recommend 8)
2. Enter a decimal number for the Upper Limit. Enter a decimal number for the Lower Limit.
3. The Upper Limit must be greater than the Lower Limit. The values for the limits depend on the application, the configuration of other options, and the distance at which you choose to flag.
4. Click on “Write” and then click on “Read” and verify that the desired limit values are correct (verify that the values entered for intended limits are the same values in the field box after clicking on “Read”). If not, repeat Steps 2 and 3.
5. Double click “Read/Clear I-Status” to clear status.
6. Now you may choose to manually poll the Interrupt pin (pin 7 on package), or for it to happen automatically. To do it manually, simply click on “Sample Ext. Interrupt Pin” when desired. To do it automatically, ensure that the “Poll External Intr.” box is selected.
7. Interrupt is set up now and you may begin collecting data. Data is collected within the Upper Limit and Lower Limit. The black box means unflagged status. On the other hand, if the data is collected either above the Upper Limit or the lower of the Lower Limit, then the black block will be red, which means the flag has been triggered.

Application Note 1591

- **Collect Data Graphical Real Time Data** allows you to sample data (whether ALScont, IRcont, ALS Once or IR Once). Samples are now being taken and are being plotted, and appropriate values are displayed on the right in the corresponding box.
- **“Stop Data Acquisition”** stops sampling of data.

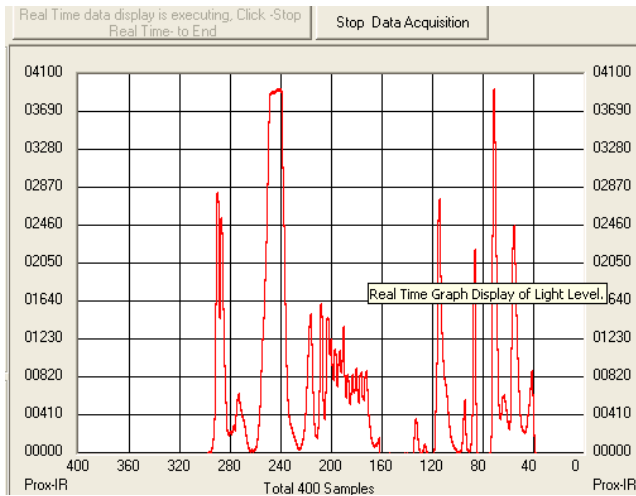

FIGURE 18.

Here the scale can be adjusted to meet your sampling needs. **“Manual Re-Scale”** allows you to type in the Maximum and Minimum values for the scale (vertical axis) in the appropriate boxes. The **“Automatic Re-Scale”** button is useful if the sampled data is out of the range of the graph or you need to zoom-in on data. It will rescale the vertical axis to an appropriate field of view.

- **Exit** - this button closes the entire program
- The value in the **“ADC Reading”** and/or **“Lux Reading”** fields are the appropriate output coming out of the sensor according to which Mode is engaged (Figure 19).
- **Max Min Count** - This is the maximum value that can be measured based on the resolution chosen (Integration Time). Max count increases with more Integration Time.

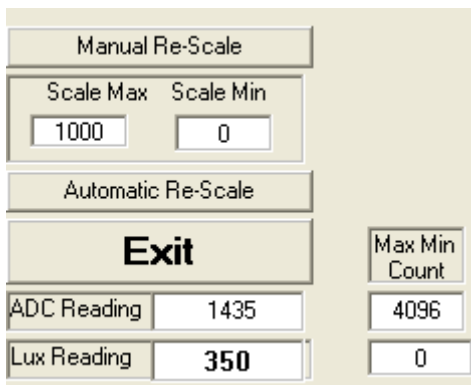

FIGURE 19.

Saving Measurements to File

To save a series of ALS and PROX measurements to disk, see the **“Save Measurements to File”** box at the very bottom of the GUI. The user may click **“Browse”** to select a filename/file path and click **“Write to Disk”** to write the current graph data to disk.

Running the Program for ISL29020

To open the program, go to the **“Start”** menu, as shown in Figure 20.



FIGURE 20.

- (Start →Intersil →Intersil_29XXX_HID→ Intersil_29XXX_HID)
- Once you have double clicked the program, the window displayed in Figure 21 should open



FIGURE 21.

- Go to **“Device Select”** tab and select whichever Device you have connected to your computer; for this example we will use **“ISL29020”**
- The **“ISL29020 Multi-Function Sensor Evaluation Software USB HID Version”** window should open the main window in which all demonstrations will be done

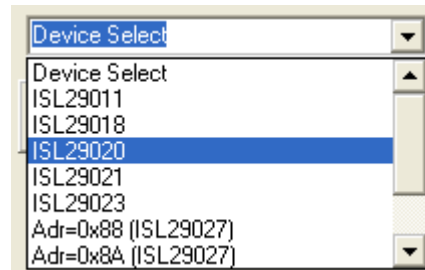

FIGURE 22.

- **USB Communication**- Check to make sure the light shown in Figure 23 is green. If it is not green, check your connection



FIGURE 23.

- **Test Communication** with the IC by clicking the button shown in Figure 24; if it shows **“good”**, then the Hardware and Software are properly set up; if it says **“fail”**, then check your connections. If the problem still persists, then you may want to restart the software.



FIGURE 24.

Application Note 1591

The section shown in Figure 25 allows the ADC-Core to be enabled. The user needs to check “Enable ADC-Core” in order to enable the devices.

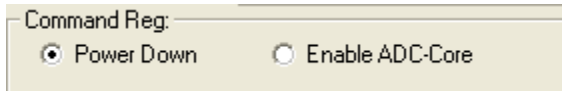

FIGURE 25.

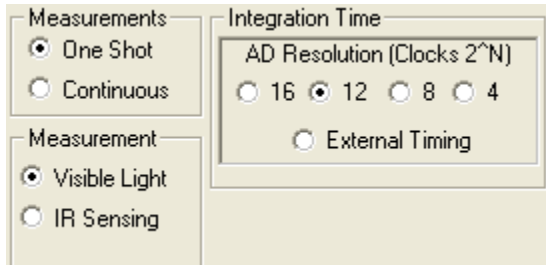

FIGURE 26.

The section shown in Figure 26 allows the user to choose either one shot or continuous measurement for visible or IR sensing and change our ADC resolution for 16-bit or 12- or 8-bit or even 4-bit ADC. However, Intersil recommends to run 12-bit ADC or 16-bit ADC for better 50/60Hz reject.

The “External Timing” check box is another option to run when using external customer supplied timing.

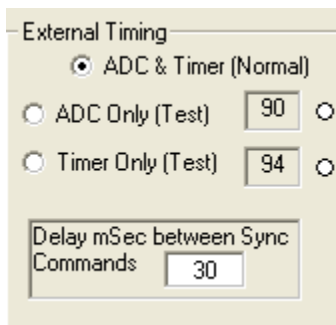

FIGURE 27.

Once the external timing from Integration Time is selected, Figure 27 will appear. The External timing allows ADC or Timer tests to be read and is able to choose the timing between pulses (~2 pulses). For more information about external timing, refer to the data sheet

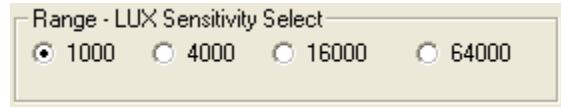

FIGURE 28.

Range-LUX Sensitivity Select allows the user to choose the sensitivity of the sensor based on external conditions/object detection. For example, a really bright object would require a higher range (i.e., 64000), versus a dark object, which would require a low range (i.e., 1000). Higher range reduces photo detector sensitivity.



FIGURE 29.

The section shown in Figure 29 allows the user to choose REXT to fix its internal oscillator frequency. 500kΩ is recommended for the devices.

Collect Data Graphical Real Time Data allows you to sample data (whether ALScont, IRcont, ALS Once or IR Once). Samples are now being taken and are being plotted, and appropriate values are displayed on the right in the corresponding box.

- **Stop Data Acquisition** stops sampling of data. Here the scale can be adjusted to meet your sampling needs.
- **Manual Re-Scale** allows you to type in the Maximum and Minimum values for the scale (vertical axis) in the appropriate boxes.
- **Automatic Re-Scale** button is useful if the sampled data is out of the range of the graph or you need to zoom-in on data. It will rescale the vertical axis to an appropriate field of view.
- **Exit** - this button closes the entire program
- The value in the “ADC Reading” and/or “Lux Reading” fields are the appropriate output coming out of the sensor according to which Mode is engaged.

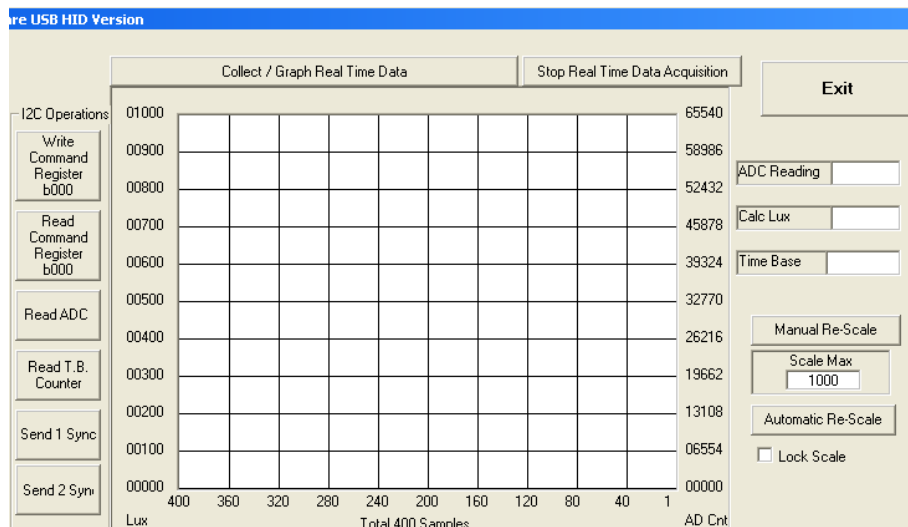

FIGURE 30.

Application Note 1591

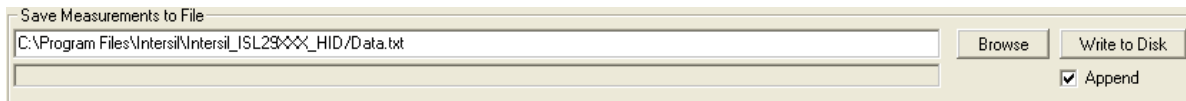

FIGURE 31.

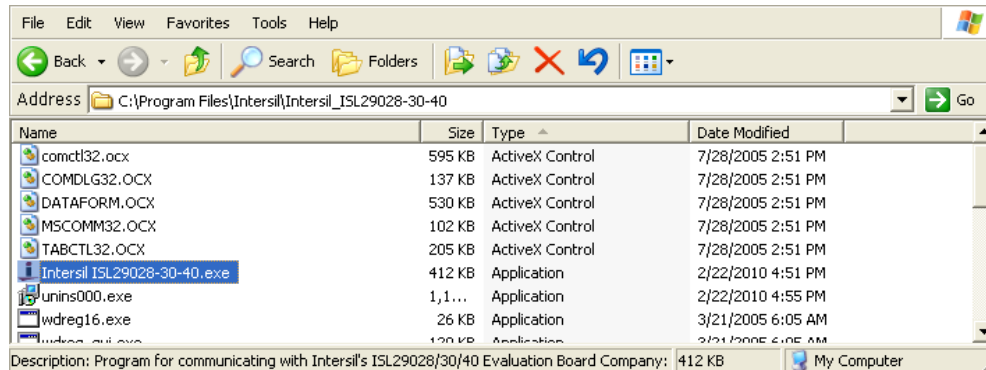

FIGURE 32. LOCATION OF EXECUTABLE ON USER'S HARD DRIVE

Saving Measurements to File

To save a series of ALS and PROX measurements to disk, see the “Save Measurements to File” box at the very bottom of the GUI. (Figure 31). The user may click “Browse” to select a filename/file path and click “Write to Disk” to write the currently graph data to disk.

Hardware Setup ISL29028 Family

Schematic and Layout

The PCB schematic and Layout are contained on the CD-ROM included with this evaluation kit (also see Figures 38 through 40). If lost, contact the local Intersil sales/FAE team. (<http://www.intersil.com/cda/Support/contacts/>)

Connecting the PCB to PC

Insert the USB-B plug into the Intersil evaluation PCB, and the USB-A plug into the user's PC. As seen in Figure 34, the status of the PC->PCB communication link is displayed in the colored box next to “Attached”.

Jumpers on PCB

The “rev B” evaluation board has 4 jumpers, which control various aspects of the part. By default, the jumpers *JP_IC*, *JP_MISC*, and *JP_IRLED* need not be connected due to the 0Ω resistors *R6*, *R7*, and *R8* which connect to a 3.3V rail. If the user desires to test part performance at voltages other than $V_{DD} = V_{IR-LED} = V_{I2C} = 3.3V$, unsolder these resistors, use the installed test points, and power any of the 3 rails as desired.

TABLE 2. JUMPER OVERVIEW

DESIGNATOR	FUNCTION
JP_PIN1	ISL29028: Changes I ² C address ISL29030: Leave open (see below)
JP_IC	Connects 3.3V rail to VDD
JP_MISC	Connects 3.3V rail I ² C pull-up, INT, PIN1
JP_IRLED	Connects 3.3V rail to the IR-LED D1

JP_PIN1

The jumper *JP_PIN1* is connected to pin 1 of the ODFN and should be **disconnected** for ISL29030 usage, and **will work in either state** for the ISL29028. The ISL29030 has a current source on pin 1. The ISL29028 has an I²C address select line tied to pin 1.

Running the Program for ISL29028 Family

If the user has selected the default installation path, the software will install in the following folder: *C:\Program Files\Intersil\Intersil_ISL29028-30-40* as seen in Figure 32. Double-click the highlighted executable shown in Figure 32 to start the evaluation software. A shortcut to this file is also provided via the Windows Start Menu under *All Programs* → *Intersil* → *Intersil ISL29028-30-40*.

Connect the PC to the evaluation PCB via a USB cable. When this connection is made, the “Attached” box displayed in Figure 33 should turn green.

The ISL29028 has a selectable I²C address (see pin *ADDR0*). By changing the input logic signal (via jumper *JP_PIN1*), the I²C address can be set to either 0x88 or 0x8A (see the PCB schematic/IC data sheet for more information). This board is shipped with jumper *JP_PIN1* removed, so by default the part will respond to I²C address 0x88.

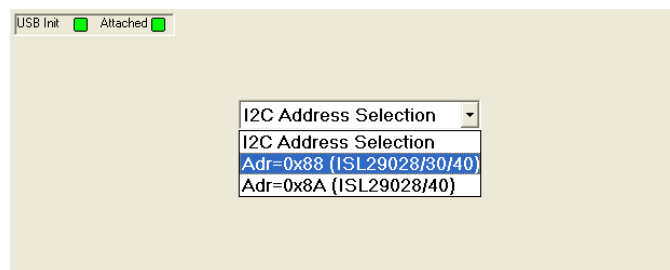

FIGURE 33. SOFTWARE START-UP SCREEN

Application Note 1591

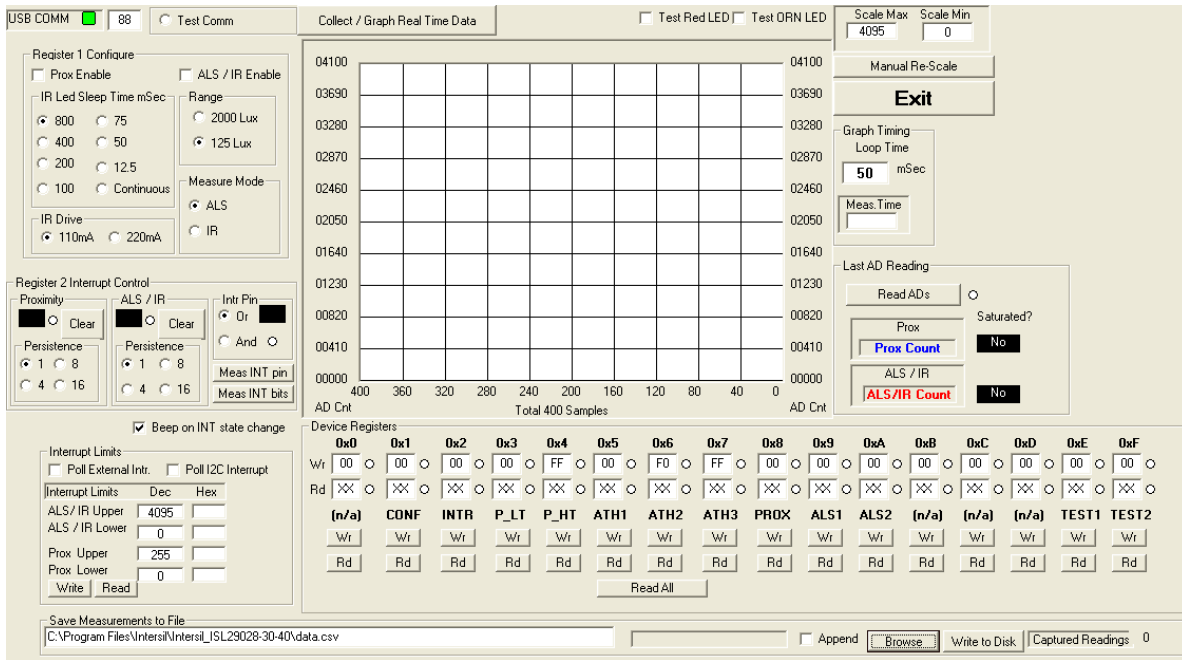

FIGURE 34. SOFTWARE MAIN SCREEN

Main Window

The main evaluation software window can be seen in Figure 34.

If the user desires to change the I²C address the GUI communicates with, see the upper-left box containing “88” in Figure 34. Change the number as desired and click the “Test Comm” box to test for a valid communication link between the PC and Light Sensor at the specified I²C address.

REGISTER 0X01 – CONFIGURE MODES

IC register 0x01 controls the range and modes of the part. “Sleep time”, “Range” and “Measure Mode” bits are explained in detail in the data sheet. All control bits *not* related to the interrupt function are located in this register.

REGISTER 0X02 – INTERRUPT BEHAVIOR

IC register 0x02 contains the interrupt flags and controls the interrupt modes. Interrupt persistence, and AND/OR (see bit 0) functionality is contained in this register.

REGISTERS 0X03 TO 0X07 – INTERRUPT THRESHOLDS

The PROX interrupt thresholds and ALS thresholds are stored in registers 0x03 to 0x07. They can be edited by writing values to the “Interrupt Limits” box and clicking “write”. See the IC data sheet for more information on interrupt limits.

EXTERNAL INTERRUPT AND INTERRUPT LEDS

To poll the status of the hardware INT pin, select the “Poll External Intr” check box and the on-PCB microcontroller will continuously check the logic state of the INT line. To poll the status of ALS_FLAG and PROX_FLAG interrupt bits (in register 0x02), select the “Poll I²C Interrupt” check box - the GUI will perform an I²C read and then instruct the microcontroller to turn

D3/D4 on or off depending on the state of ALS_FLAG and PROX_FLAG.

COMPLETE REGISTER LISTING

The “Device Registers” box at the bottom of the GUI displays a complete listing of all registers in hex format and should automatically update based on the options selected by the user. Users can individually write to or read from these registers using the “Wr”/“Rd” buttons.

REAL-TIME DATA ACQUISITION GRAPH

To graphically display the results of ALS and proximity conversions, first click the check boxes “ALS /IR Enable” and “Prox Enable” and select the mode of operation by using the radio buttons in the “Register 1 Configure” area. After this register is configured, click the “Collect Data” button shown in the upper-left of Figure 35. Both ALS and Proximity conversions can happen (and are displayed) at once because the ISL29028 architecture has two concurrent ADCs.

ADC RESOLUTION AND GRAPH RESCALING

Because the ALS conversions are inherently 12-bit ($2^{12}-1 = 4095$ count maximum), and the proximity conversions are inherently 8-bit ($2^8-1 = 255$ count maximum), the graph may require rescaling to view both results on the same curve at once. To set a new maximum and minimum graphical scale, change the numbers in the “Scale Max” and “Scale Min” boxes, then click “Manual Re-Scale”.

SAVING MEASUREMENTS TO FILE

To save a series of ALS and PROX measurements to disk, see the “Save Measurements to File” box at the very bottom of the GUI. The user may click “Browse” to select a filename/filepath and click “Write to Disk” to write the currently graphed data to disk.

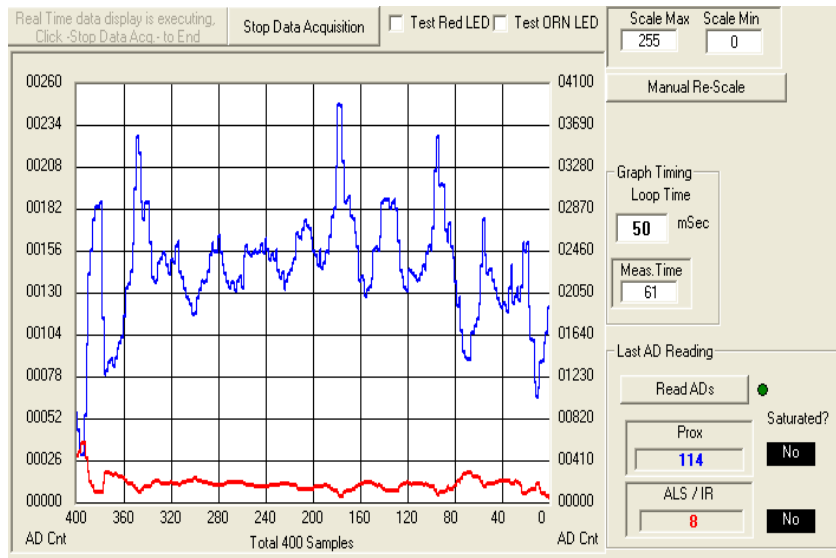

FIGURE 35. REAL-TIME DATA ACQUISITION GRAPH

Troubleshooting

- If suffering from poor USB connection; the USB port may need to change.
 - If the Proximity sensor is unable to measure anything within a certain distance, the sensor has saturated and the Selectivity parameter needs to be increased.
 - If the program says connection fail and the sensor instantly stops working, then simply unplug it from the computer and plug it back in. If the problem still persists then unplug, close the program, plug it back in, and reopen the program.
 - If during a measurement, the program crashes or instantly the Evaluation board is no longer detected as being connected, then unplug and plug back in.
 - If too much noise is being picked up, then increase the Frequency parameter.
 - If you require better detection of far distances, then increasing the current parameter will help.
 - Also recall that since this is an optoelectrical part with a clear package, performance may be sensitive to aggressive scratching or damaging.
- If the message “Please check USB connection” appears right after trying to run the program, you have an older version of the software GUI or the USB is not connected to the PC. Go back and check the micro-controller board to see if it is marked “HID” version or not. If not, you have the “Jungle” version.

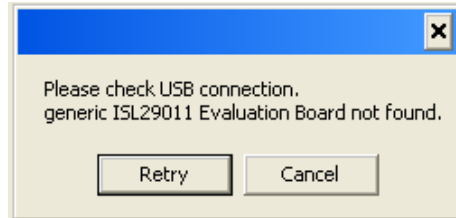

FIGURE 36.

- If you have WIN7 installed on you PC and you are trying to run an Intersil Program, then you will get the message shown in the following.

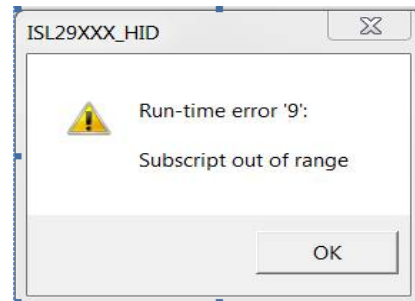
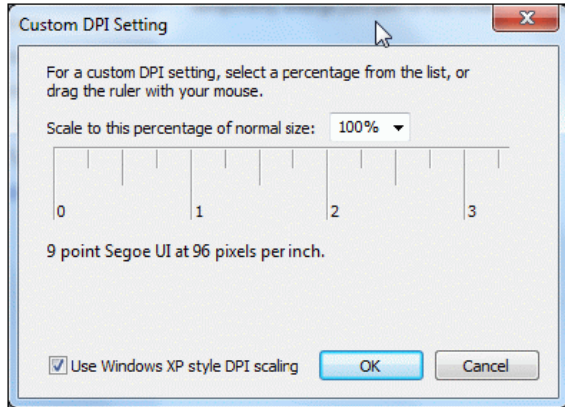

FIGURE 37.

Application Note 1591

- The following screen shown may be caused by the PC monitor. The solution is to resize the set custom text size (DPI) by going to Control Panel -> Appearance and Personalization -> Display -> Set custom text size (DPI) and choose "Scale to this percentage of normal size: 100%" (96pixels/inch).

For other questions, comments, and feedback, contact the local Intersil FAE/Sales team.
<http://www.intersil.com/cda/Support/contacts/>



Evaluation Boards Schematics

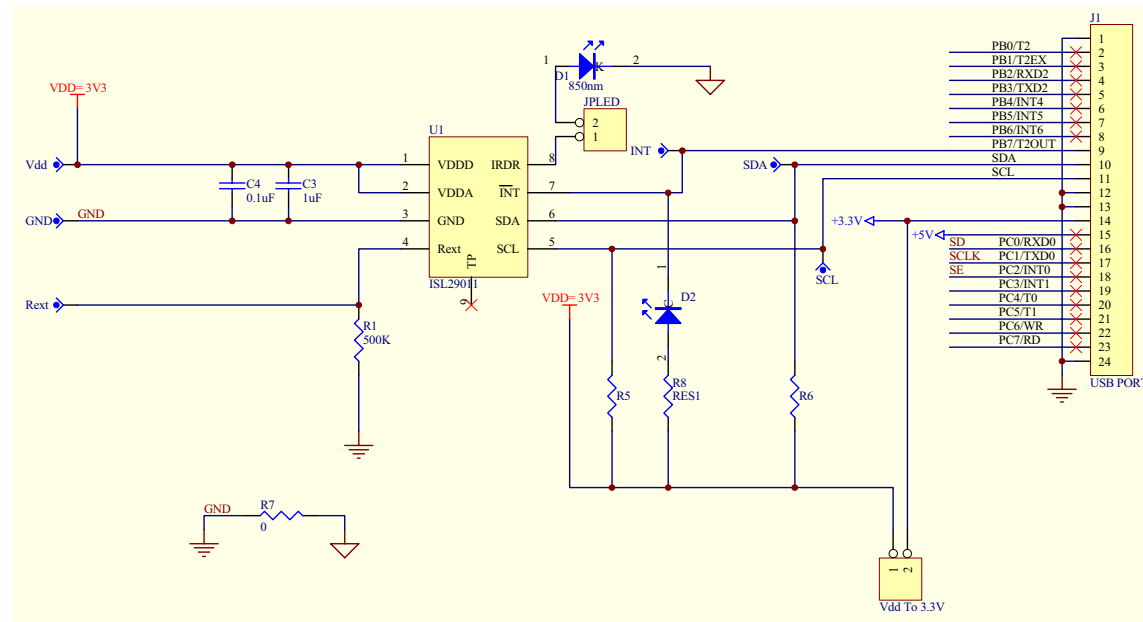

FIGURE 38. ISL29011, ISL29018, ISL29021 EVALUATION BOARD SCHEMATIC

Evaluation Boards Schematics (Continued)

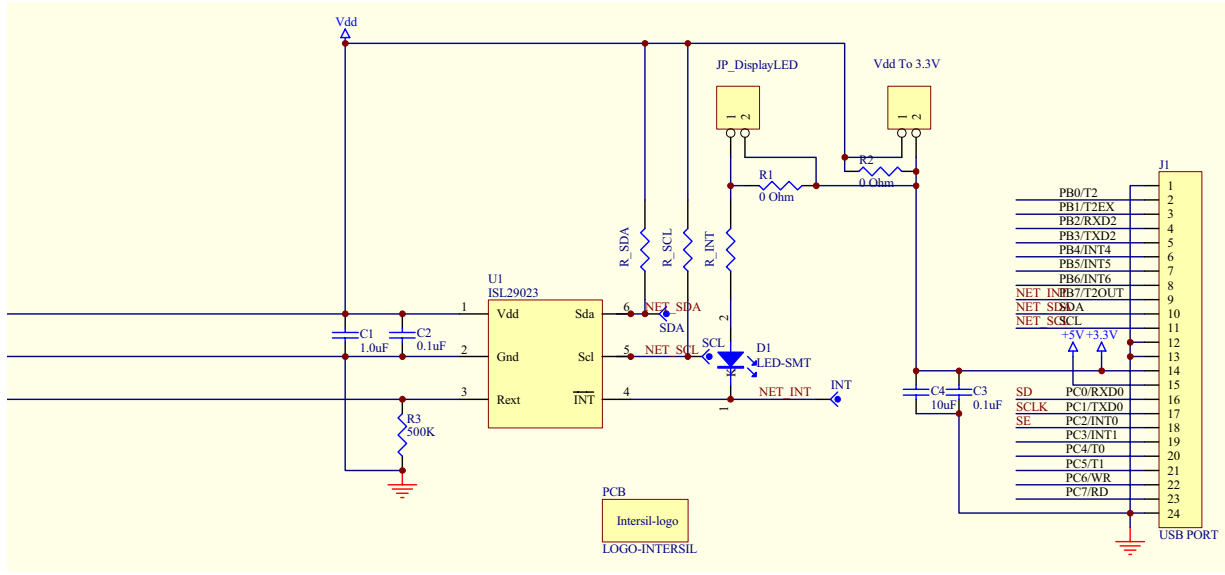

FIGURE 39. ISL29023 EVALUATION BOARD SCHEMATIC

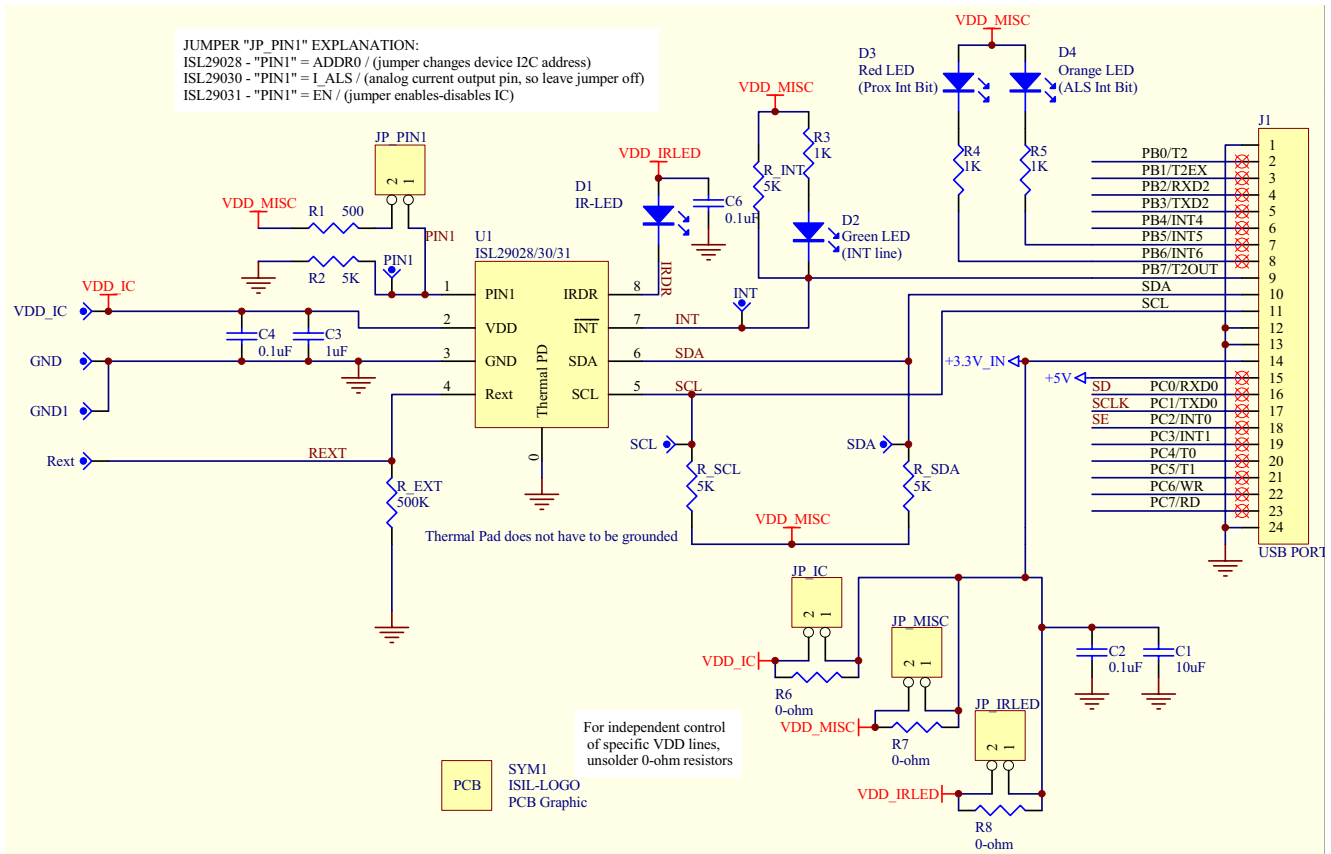

FIGURE 40. ISL29028 EVALUATION BOARD SCHEMATIC

Intersil Corporation reserves the right to make changes in circuit design, software and/or specifications at any time without notice. Accordingly, the reader is cautioned to verify that the Application Note or Technical Brief is current before proceeding.

For information regarding Intersil Corporation and its products, see www.intersil.com